

# *Reducing the Uncertainties in Fusion Fuelling at JET*



***T. Coyne<sup>1</sup>, S. Davies<sup>2</sup>, C. Robertson<sup>2</sup>,  
A. Rees<sup>2</sup>, A Miller<sup>1</sup>***

*<sup>1</sup>Euratom /UKAEA Culham Science Centre, Abingdon, OX14 3DB, UK.*

*<sup>2</sup>Hiden Analytical Ltd. 420 Europa Boulevard, Warrington. WA5 7UN, UK*

***UK 9<sup>th</sup> RGA Users Meeting / Vacuum  
Symposium, 10th Feb, 2010***

**Plasma physics closest to ITER**

<b>Torus radius</b>	<b>3.1 m</b>
<b>Vacuum vessel</b>	<b>3.96m high x 2.4m wide</b>
<b>Plasma volume</b>	<b>80 m<sup>3</sup> - 100 m<sup>3</sup></b>
<b>Plasma current</b>	<b>up to 5 MA</b> in present configuration
<b>Main confining field</b>	<b>up to 4 Tesla</b>



**Unique technical capabilities :**

- **Tritium**
- **Beryllium**

**⇒ Optimise the use of JET in support of ITER  
by making use of its unique capabilities**

## 8<sup>th</sup> RGA (Culham); Outlined problems at JET with analysis of primary fuels for fusion process

## RGA: JET quantitative analysis is always difficult;

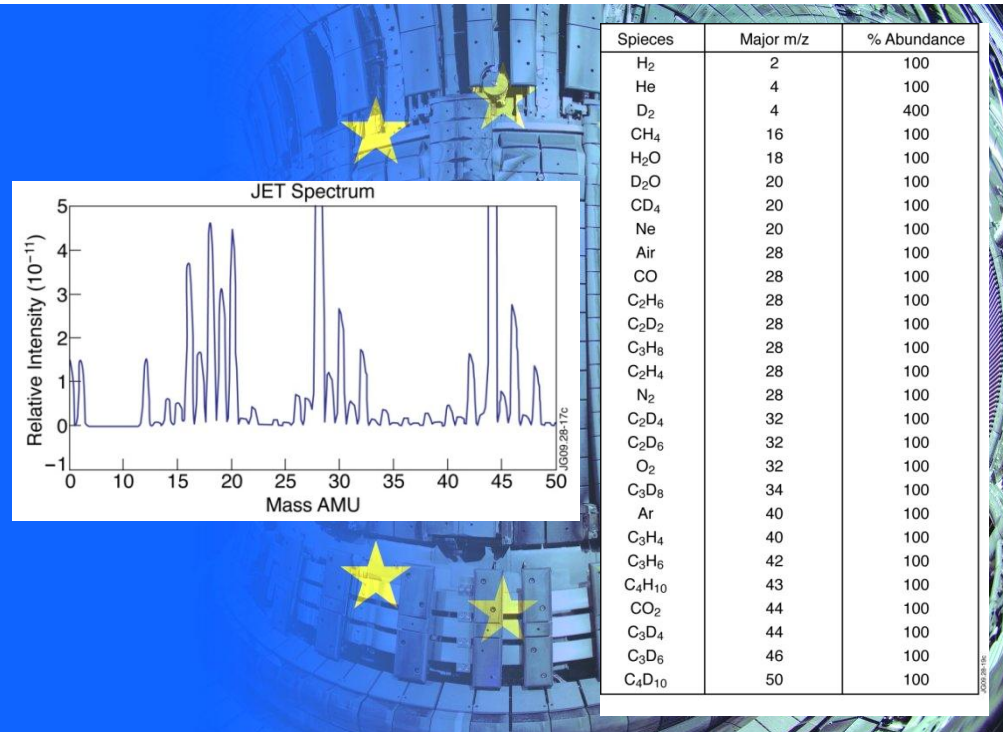

3 types of Hydrogen isotope: Hydrogen, Deuterium and Tritium.

• 2 types of Helium: <sup>3</sup>He, <sup>4</sup>He

• 3 types of Water, H<sub>2</sub>O/ Heavy Water, D<sub>2</sub>O / Super Heavy Water, T<sub>2</sub>O.

• 6 Tonnes of Carbon tiles, complex Carbon / Hydrogen isotope interactions.

Baking the vessel to temperatures in excess of 300 degrees Celsius further complicates an already difficult task due to the dissociation of C<sub>x</sub>H<sub>y</sub> and C<sub>x</sub>D<sub>y</sub> species from the vessel wall.

⇒ Of most importance, validation of primary fuel purity is vital to ensure the data obtained from plasma pulses is in line with the strict experimental requirements and that pulse recipe repeatability is not compromised ⇒

## Validation of JET primary fuel purity; Why is it difficult?

## Fusion fuel most commonly used in the JET Tokamak is Deuterium ( $D_2$ );

### • Fundamental Problem ⇒

- Suspicions of Helium ( $^4He$ ) contamination in Primary Gas Introduction fuelling modules (GIM).
- Validation of primary fuel is complicated due to  $D_2$  and  $^4He$  having the same atomic mass (4 amu), specifically a mass separation of just 0.0254amu.
- Validation not possible using conventional mass spectrometry RGA techniques.
- Potential solution ⇒ other analytical techniques considered for quantitative gas analysis at JET; TOF, optical spectroscopy and advanced QMS RGA techniques.

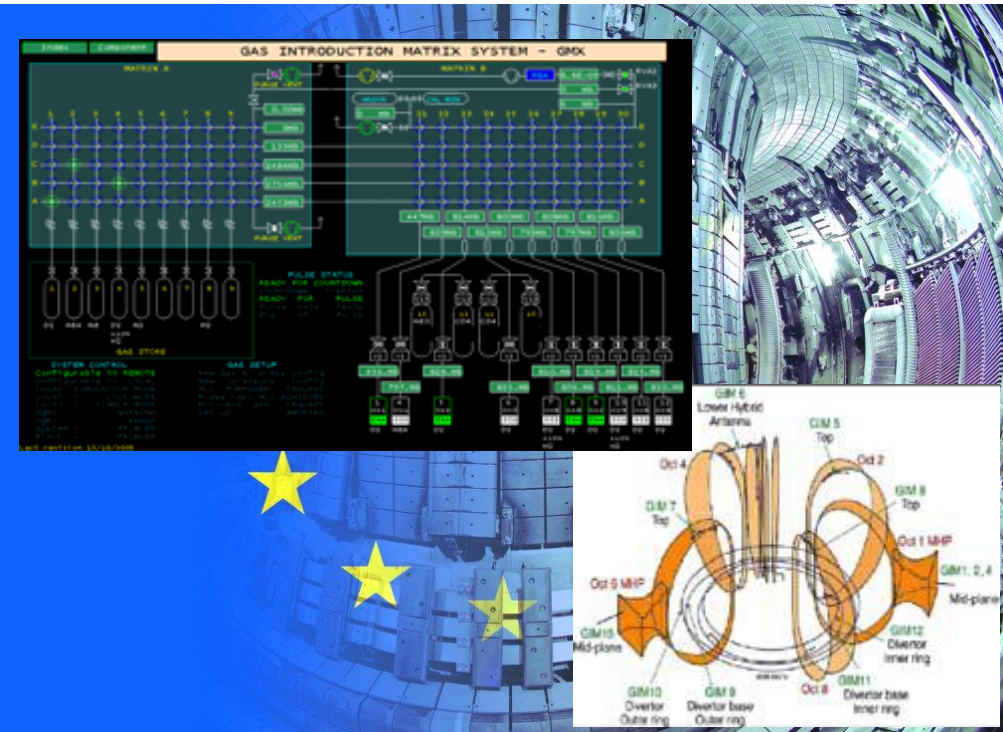

⇒ **Solution: Advanced QMS RGA Technique; validation of primary fuel purity using a complimentary quadrupole mass spectrometry technique (TIMS). ⇒**

## Validation of JET primary fuel purity; TIMS qRGA

## Threshold Ionization Mass Spectrometry (TIMS)

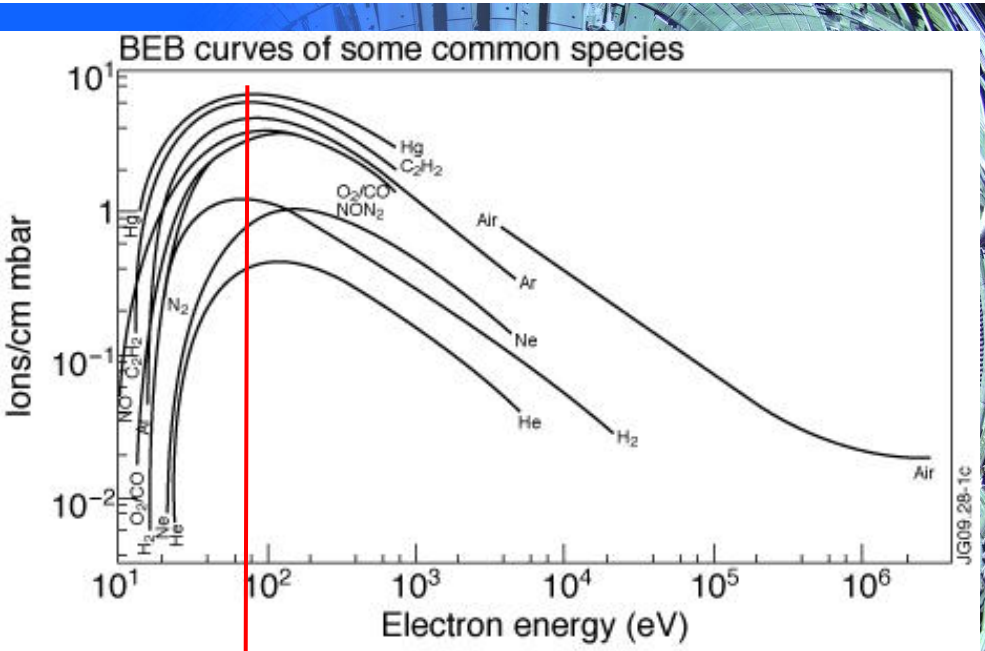

- TIMS: Hiden Analytical qRGA can be operated in a mode allowing control over the energy of the electrons emitted within the ionization source. (0.5eV electron energy resolution)

- Different species have defined unique ionization energies, dependent on the electron orbital configuration: outer shell electrons ⇒ weaker ionization energies due to greater distance and lower electrostatic forces from the nucleus.

- Ionization process of neutral particles commences at a minimum (threshold) energy of the impacting electrons ⇒ each species has unique fingerprint

Electron energy set at 70eV

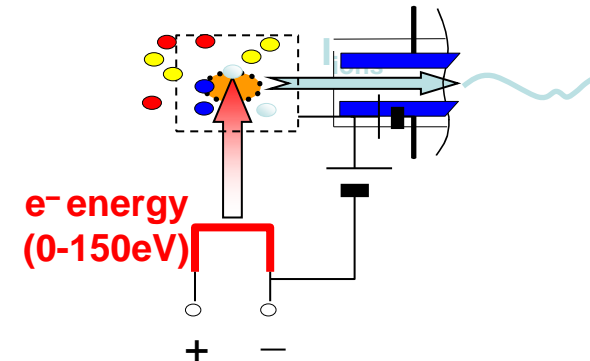
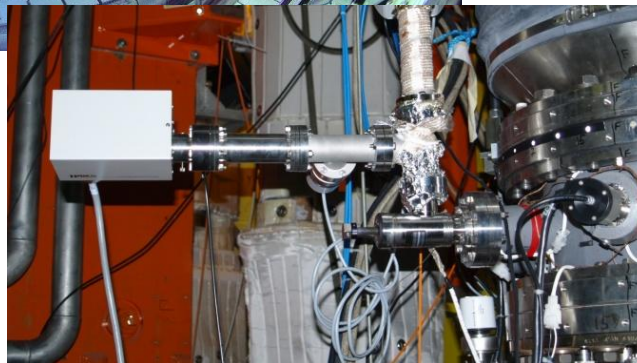

## Validation of JET primary fuel purity; TIMS qRGA

## Threshold Ionization Mass Spectrometry (TIMS)

- TIMS: Hiden Analytical qRGA can be operated in a mode allowing control over the energy of the electrons emitted within the ionization source.

- $D_2$  and  $^4He$  have overlapping atomic mass (4 amu), but Binary Encounter Bethe (BEB) theory and experimental data have shown threshold ionization energies (electron impact) are separated at 15.4eV and 24.5eV respectively.

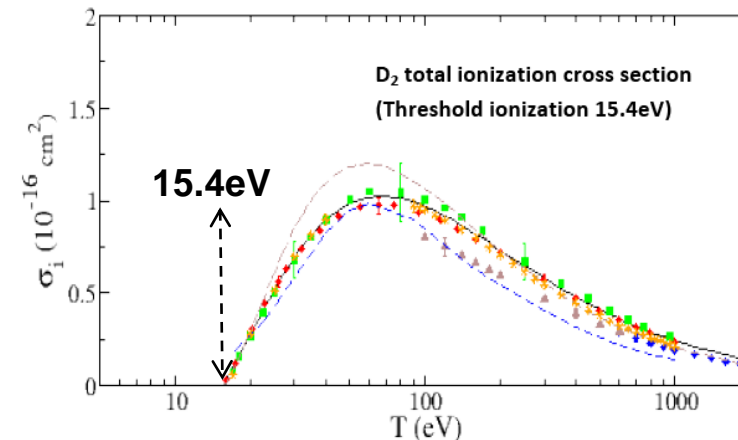
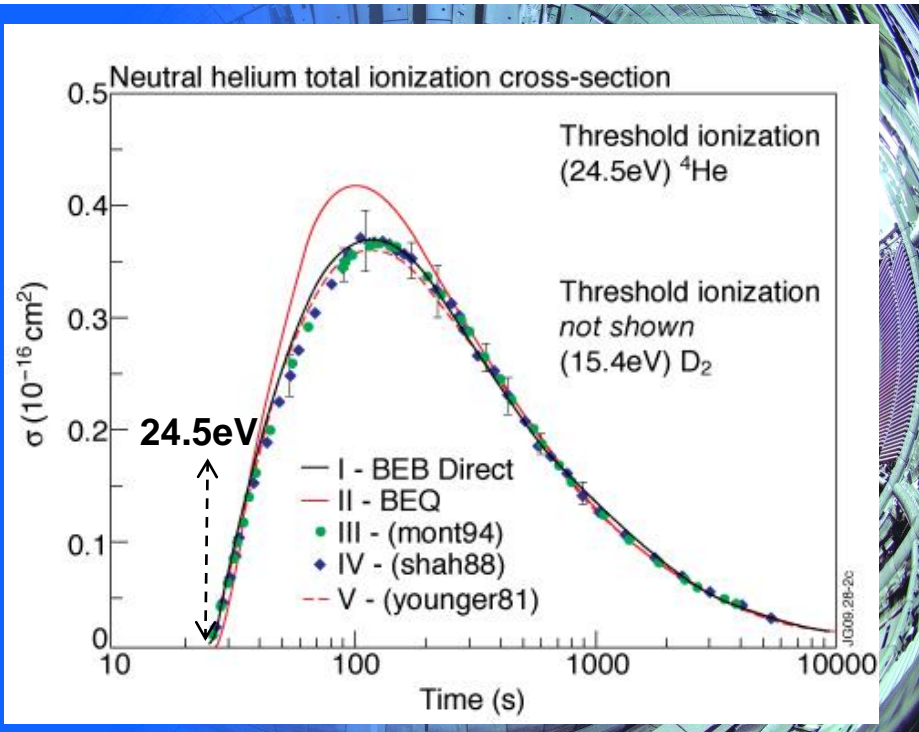

How do the electron impact threshold ionization curves appear in the real qRGA with the (TIMS) technique? ⇒

## Validation of JET primary fuel purity; TIMS qRGA

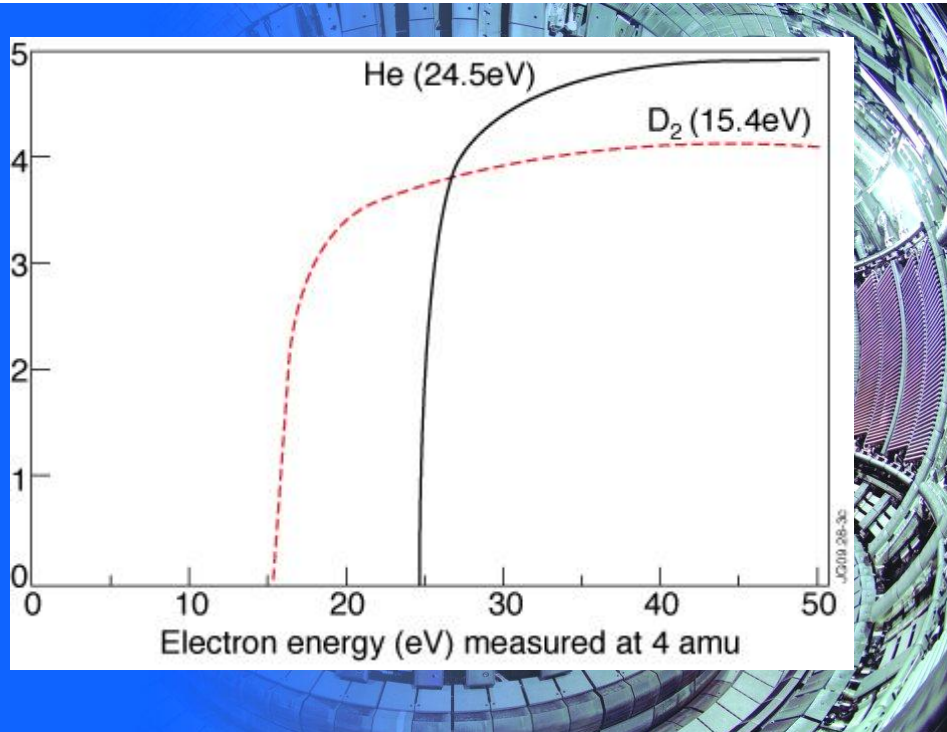

## Threshold Ionization Mass Spectrometry (TIMS)

- TIMS on the left shows how an example spectra appears with the QMS if we scan  $^4\text{He}$  and  $\text{D}_2$  separately at 4amu. Threshold ionization onset in excellent agreement with BEB values (  $\approx 0.5\text{eV}$ ).
- TIMS data below shows a real curve when we sample the convoluted  $^4\text{He}$  and  $\text{D}_2$  gas mixture (simultaneously) 0-50eV range.
- The partial pressure gradient prior to the inflection represents just  $\text{D}_2$  (in this case), with the gradient at higher electron energies representing ( $\text{D}_2 + ^4\text{He}$ )

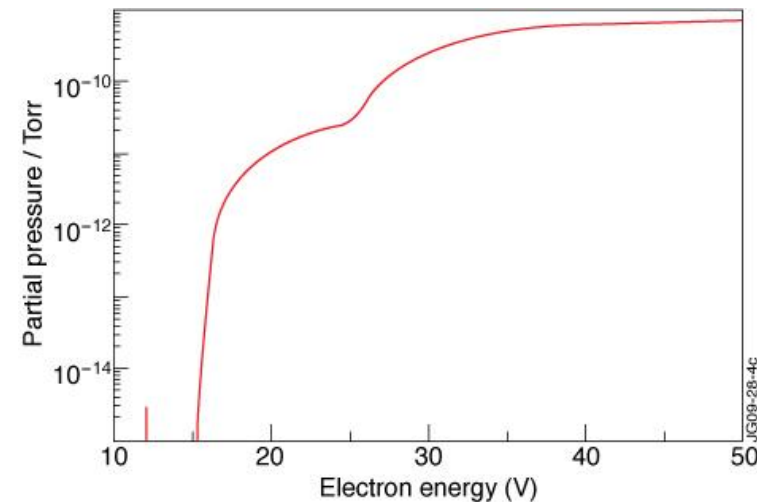

We have shown spectral deconvolution of D<sub>2</sub> & <sup>4</sup>He ; But how to quantify?

D<sub>2</sub> + <sup>4</sup>He: Quantification process with Hiden qRGA (Apply BEB theory to qRGA data) :

- BEB theory literature values gives the total ionization cross section coefficients ( $\sigma$ ) for the gas species under consideration as function impact electron energy (eV):
- Relate ( $\sigma$ ) to the qRGA measured partial pressure of the gas species (let it be denoted as ( $N_x$ ) in this case)

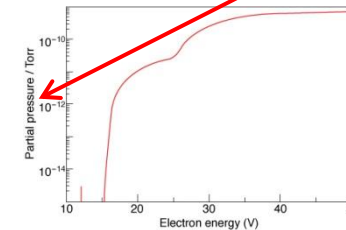
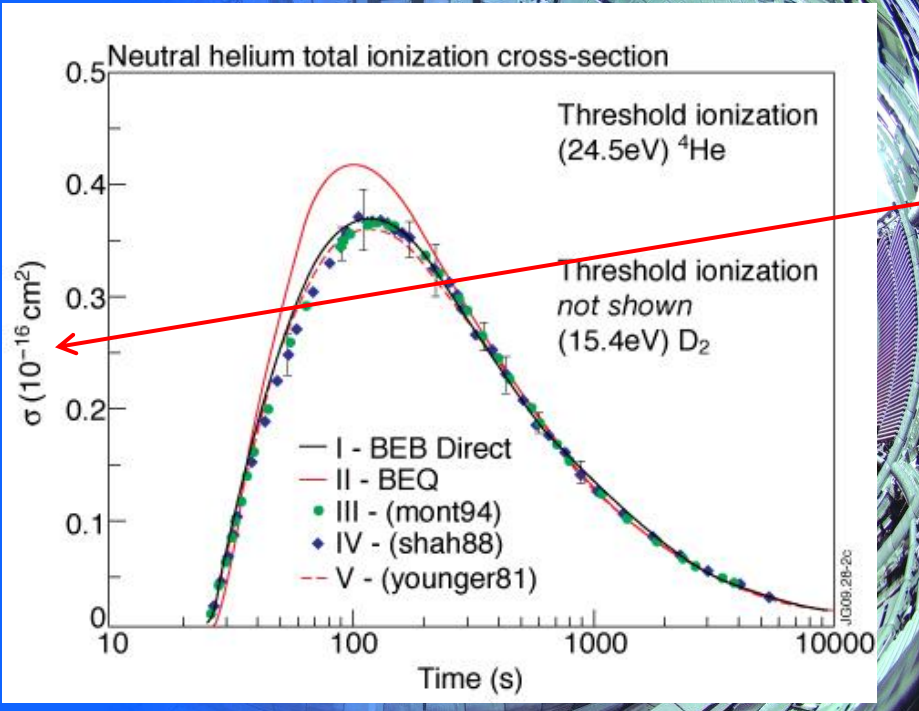

- Express the true abundance level of the gas species ( $\eta_x$ ) as a function of ( $\sigma_x$ ) and the measured partial pressures of the qRGA ( $N_x$ ) . So in the case of the D<sub>2</sub> only and (D<sub>2</sub> + <sup>4</sup>He) regions in the TIMS spectra above, we can express the following two equations (\*in this case we choose to measure at the 19eV and 31eV points on the curve\*):

$$N_{D_2} = A_i \left\{ \left\{ \sigma_{D_2}^{19eV} \right\} \eta_{D_2} \right\}$$

Eqn 1: (D<sub>2</sub>)

$$N_{D_2 + ^4He} = A_i \left\{ \left\{ \sigma_{D_2}^{31eV} \right\} \eta_{D_2} + \left\{ \sigma_{He}^{31eV} \right\} \eta_{He} \right\}$$

Eqn 2: (D<sub>2</sub> + <sup>4</sup>He)



# TIMS De-convolution of $D_2/{}^4He$ at JET:

# Testing the Model: Real time quantification of a changing $D_2/{}^4He$ mix with qRGA



- First: Solve eqns (1&2) for true  $D_2/{}^4He$  abundance ratio, then implement into qRGA Hiden software

- Controlled the ratio of the  $D_2/{}^4He$  mix by MFC method. Over a 60 minute period, the % of  $D_2/{}^4He$  ratio was varied from 50/50 to 0.1/99.9

- The qRGA data is shown below (left to right); Raw MFC data, raw TIMS data, and corrected TIMS after BEB model. The inset shows a plot of the  $D_2$  % in  ${}^4He$ . (The qRGA data is in good agreement with the MFC data).

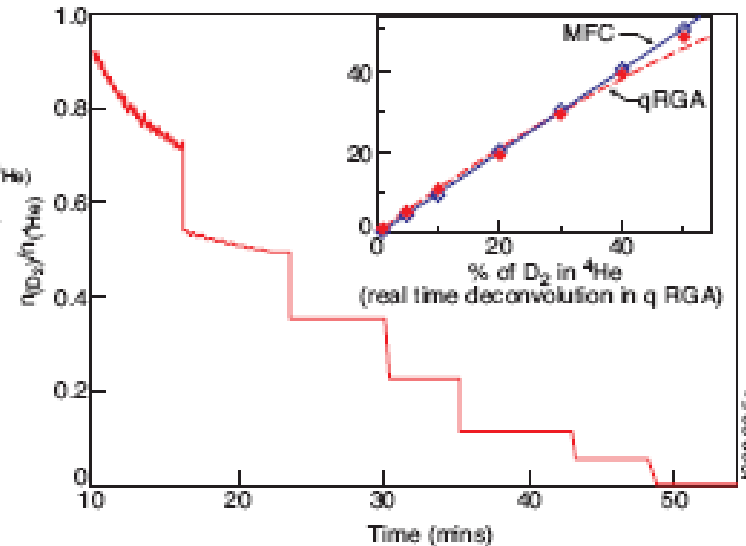
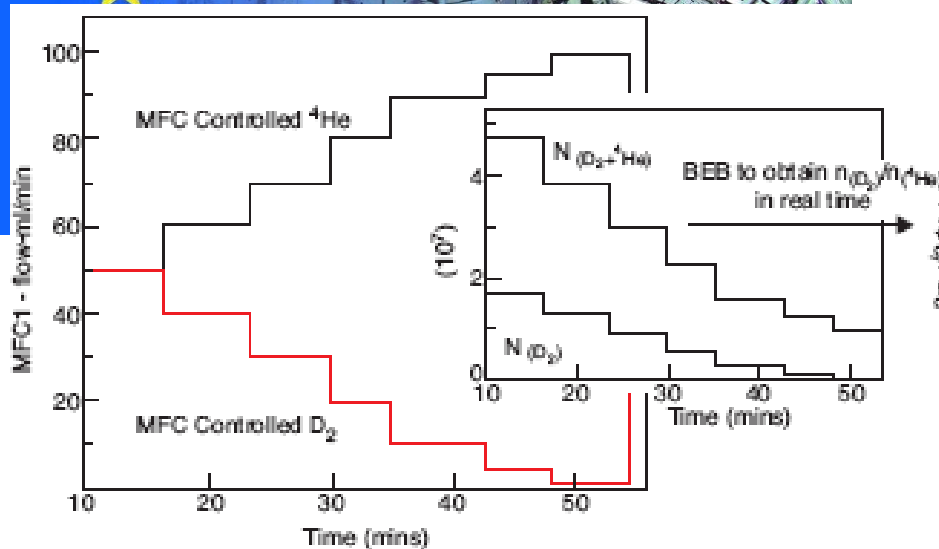

## Realising the potential of TIMS at JET:

## Not just D<sub>2</sub>/<sup>4</sup>He de-convolution!

Realising the possibilities, TIMS was used during <sup>3</sup>He operations at JET;

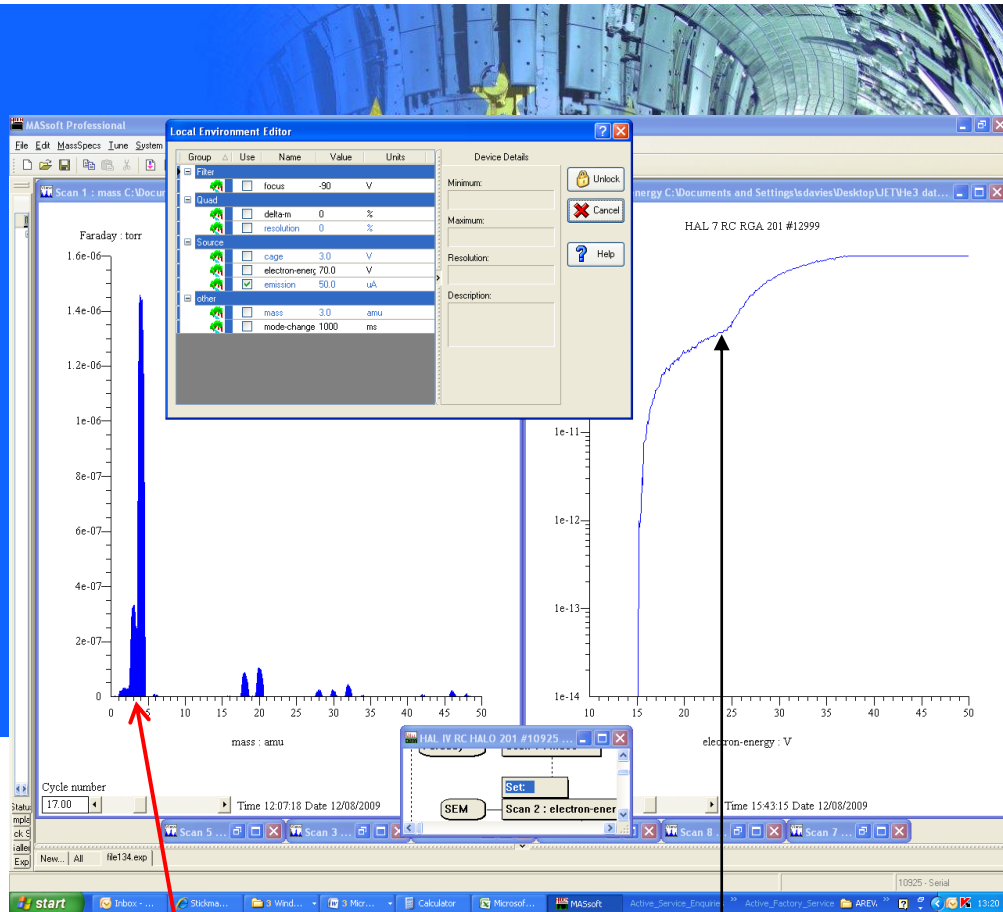

- The data follows a Ion Cyclotron heating cycle using <sup>3</sup>He as the minority gas. Varying amounts of <sup>3</sup>He was injected into the plasma.

- In standard quadrupole MS mode, the mass profile scan shows complex gas spectrum from the Torus. 2, 3 & 4 amu peaks are evident (a mix of hydrogen, deuterium and helium isotopes which cannot easily be de-convoluted)

- The qRGA spectra in TIMS mode shows a scan at 3 amu, clearly de-convoluting the <sup>3</sup>He from HD.

- The atomic mass separation of <sup>3</sup>He and HD is just 0.0058 amu; difficult for any mass spectrometer to resolve – EASY in TIMS!

2, 3 & 4 amu peaks

Transition from HD to (HD + <sup>3</sup>He)

## Realising the potential of TIMS at JET:

## Not just $D_2/{}^4He$ de-convolution!

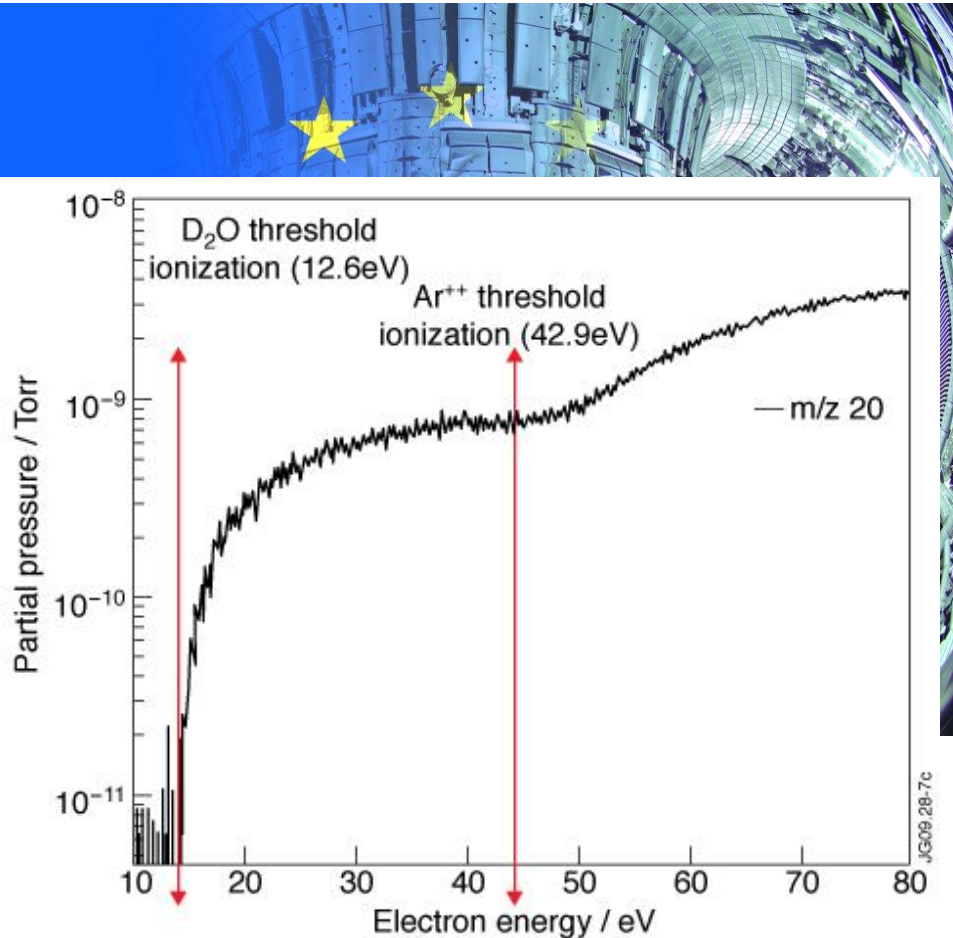

- The TIMS data shows small quantities ( $\leq 1\%$ ) of chamber residual heavy water  $D_2O$ , as shown by the electron impact threshold ionization energy at 12.6eV

- Any chamber residual Argon (40 amu), will always have a secondary doubly ionized Argon peak ( $Ar^{++}$ ) present at 20 amu. This is due to the conventional MS operating at an electron energy of  $\geq 70$ ev. ( $Ar^{++}$  is formed at 42.9eV)

- Using conventional mass profile scans,  $D_2O$  is indistinguishable from chamber residual Argon, and difficult for any conventional mass spectrometer.

- But not with TIMS!

- This de-convolution of gases at 20 amu can have an important role for monitoring vacuum quality conditions in the JET Torus (*To be discussed elsewhere!*)

## Realising the potential of TIMS at JET:

## Not just $D_2/{}^4He$ de-convolution! What about hydrocarbons and primary fuel contamination:

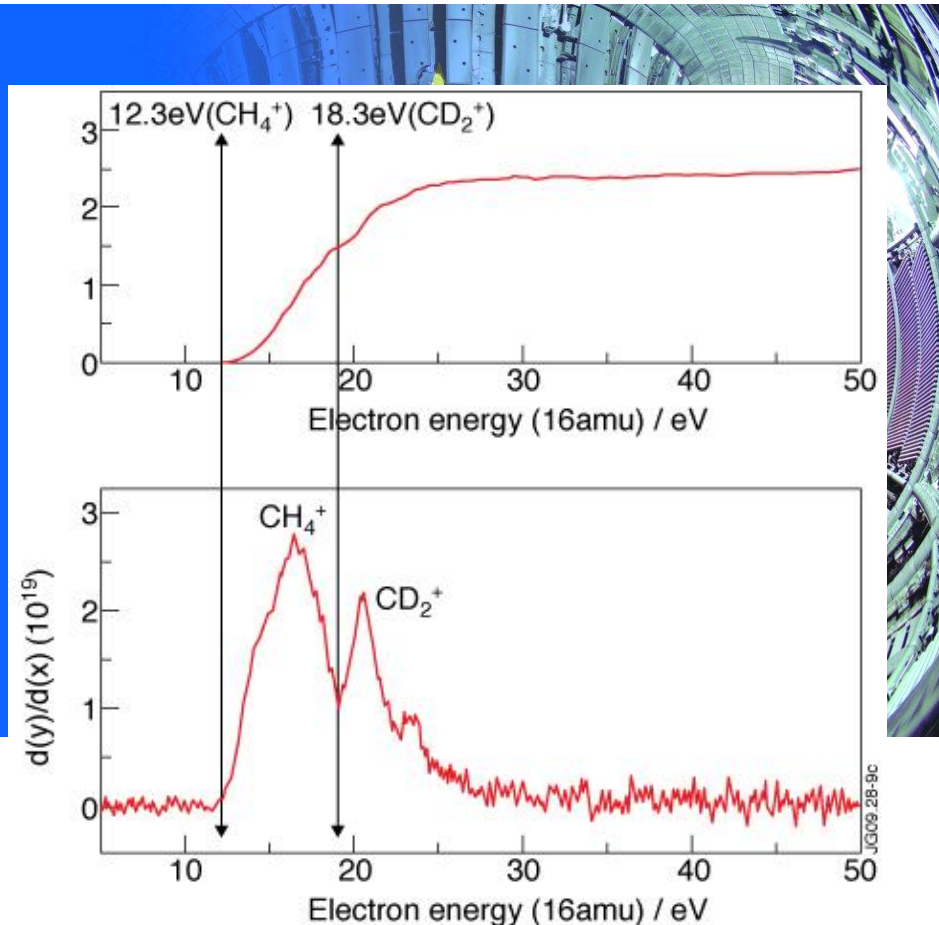

- It is known that hydrocarbons outgas from the Torus vessel wall, affecting the optimum fuelling conditions. Preliminary TIMS data shows interaction of Deuterium and hydrocarbons:  $C_xH_y \Rightarrow C_xD_y$

- Example of TIMS data: at 16 amu, overlapping species  $C_2H_4$  &  $CD_2$

- Using conventional mass profile scans, again these species are virtually indistinguishable, and difficult for a conventional mass spectrometer.

- TIMS can help circumvent this problem!

- In the figure shown, the hydrocarbon level is at 0.5% of the primary gas level, demonstrating the potential in low level impurity detection

- This technique can be applied to any hydro and deuterated-hydrocarbon species within the mass range of the qRGA

## Realising the potential of TIMS at JET: What have we learned?

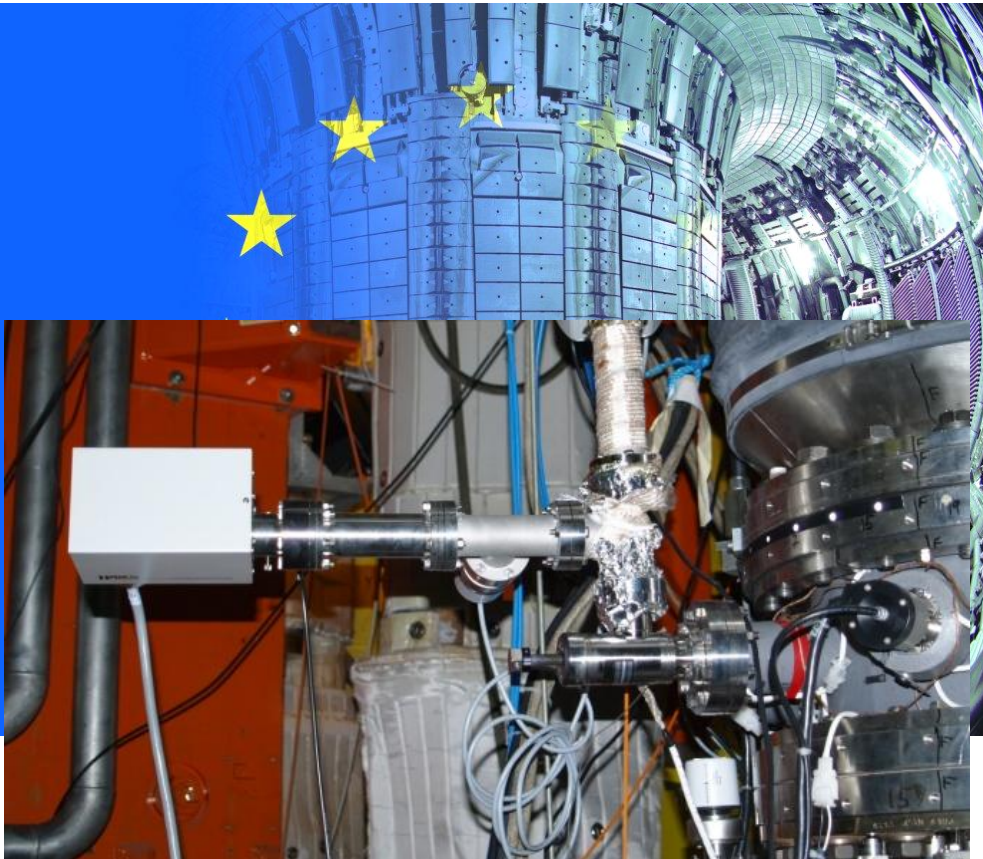

### Conclusions & Future Work:

- De-convolution of the mass spectra could lead the way to providing a better understanding of the chemistry within the Torus, and provide invaluable diagnostic information during vessel conditioning.
- Initial results prove encouraging, demonstrating discrimination of  $D_2/{}^4He$  and  $HD/{}^3He$ . We have applied BEB to TIMS data to generate algorithms in the qRGA software to automatically determine  $D_2/{}^4He$  ratio concentrations.
- This has provided stimulus to apply TIMS during future Tritium campaigns. Discrimination of  $T^+$  from  $HD^+/{}^3He^+$  ions should prove within the scope of qRGA. The separation of  $T^+$  from  ${}^3He^+$  The separation of 0.00002 amu is challenging for any mass spectrometer.
- We have seen de-convolution of  $D_2O/Ar^{++}$ , and initial data of  $CH_4^+$  and  $CD_2^+$ . This has encouraged future work, currently ongoing.
- 2010 brings the installation of the Beryllium plasma facing wall at JET and an opportunity to accurately determine the vessel chemistry during commissioning.